

Dilution™  
SOLUTIONS



# Animal Health Catalog

Chemical Delivery Made Easy

# LIVESTOCK MEDICATION

## Water-Powered Chemical Dispensers and Medicators

Dosatron's water-powered, chemical dispensers and medicators automatically compensate for flow and pressure changes providing consistent, repeatable results for your animals.

### The Dosatron DM11F Diaphragm Mediator provides:

- Enhanced features, providing longer lasting parts
- The ability to work under the toughest conditions
- The highest quality diaphragm medicator on the market

The DM11F has a wide flow range from 0.02 GPM up to 11 GPM. It is perfect for day-old chicks and also for weaners.

### Dosatron's line of medicators can accurately dispense:







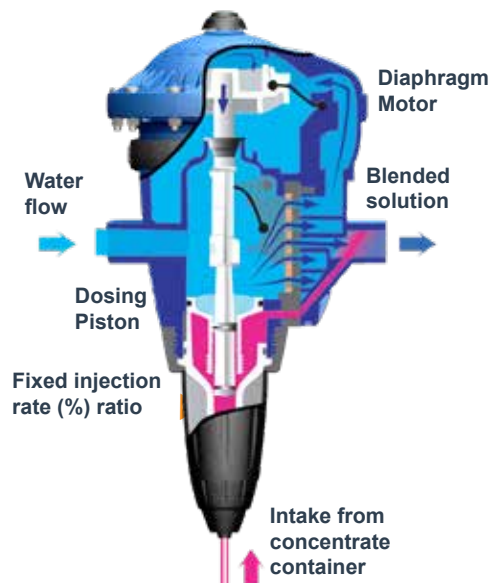

- Antibiotics and vitamins
- Electrolytes
- Chlorine
- Hydrogen Peroxide
- Vinegar and Iodine
- Line cleaners
- Nutritional supplements



DM11F  
Diaphragm  
11 GPM  
Fixed 1:128



# UNIT SPECIFICATIONS

All Purpose Medicators									
<b>MODEL</b>	D128R	D25F	D25RE2	DM11F	DM11RE3	D14MZ2	D45RE15	D40MZ2	D20S
<b>MAX. FLOW</b>	7 GPM	11 GPM	11 GPM	11 GPM	11 GPM	14 GPM	20 GPM	40 GPM	100 GPM
<b>MIN. FLOW</b>	0.09 GPM	0.05 GPM	0.05 GPM	0.02 GPM	0.02 GPM	0.05 GPM	.4 GPM	2.2 GPM	5 GPM
<b>DILUTION RANGE</b>	1:128 1:100 1:200	1:128 fixed	1:500 to 1:50	1:128 fixed	1:128 to 1:32	1:500 to 1:50	1:500 to 1:66	1:500 to 1:50	1:500 to 1:50
<b>INJECTION PERCENTS</b>	0.8 1.0 0.5	0.8%	0.2 to 2%	0.8%	0.8% to 3%	0.2% to 2%	0.2 to 1.5%	0.2 to 2%	0.2 to 2%
<b>PRESSURE RANGE</b>	7 to 70 PSI	4.3 to 85 PSI	4.3 to 85 PSI	1.5 to 85 PSI	2.2 to 57 PSI	4.3 to 85 PSI	7 to 70 PSI	4.3 to 116 PSI	2 to 120 PSI
<b>CONNECTIONS</b>	3/4" NPT	3/4" NPT	3/4" NPT	3/4" NPT	3/4" NPT	3/4" NPT	1" NPT	1 1/2" NPT	2" NPT

All units include: mounting bracket, suction hose, weighted strainer, and quick start guide.

Please review the basic installation drawing for recommended accessories.

MAXIMUM TEMPERATURE: 104 °F

## BASIC INSTALLATION

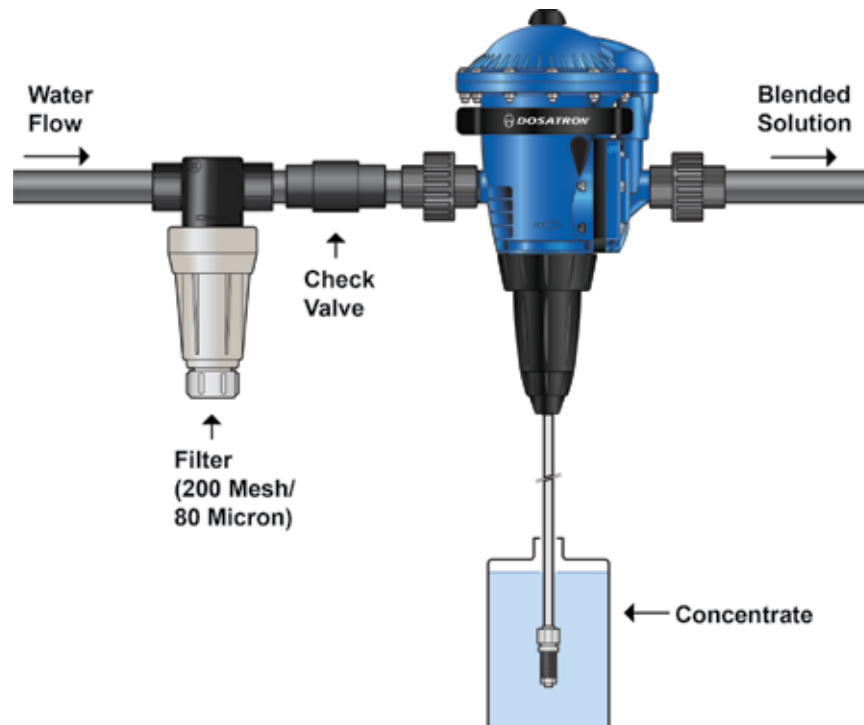

# BYPASS INSTALLATION

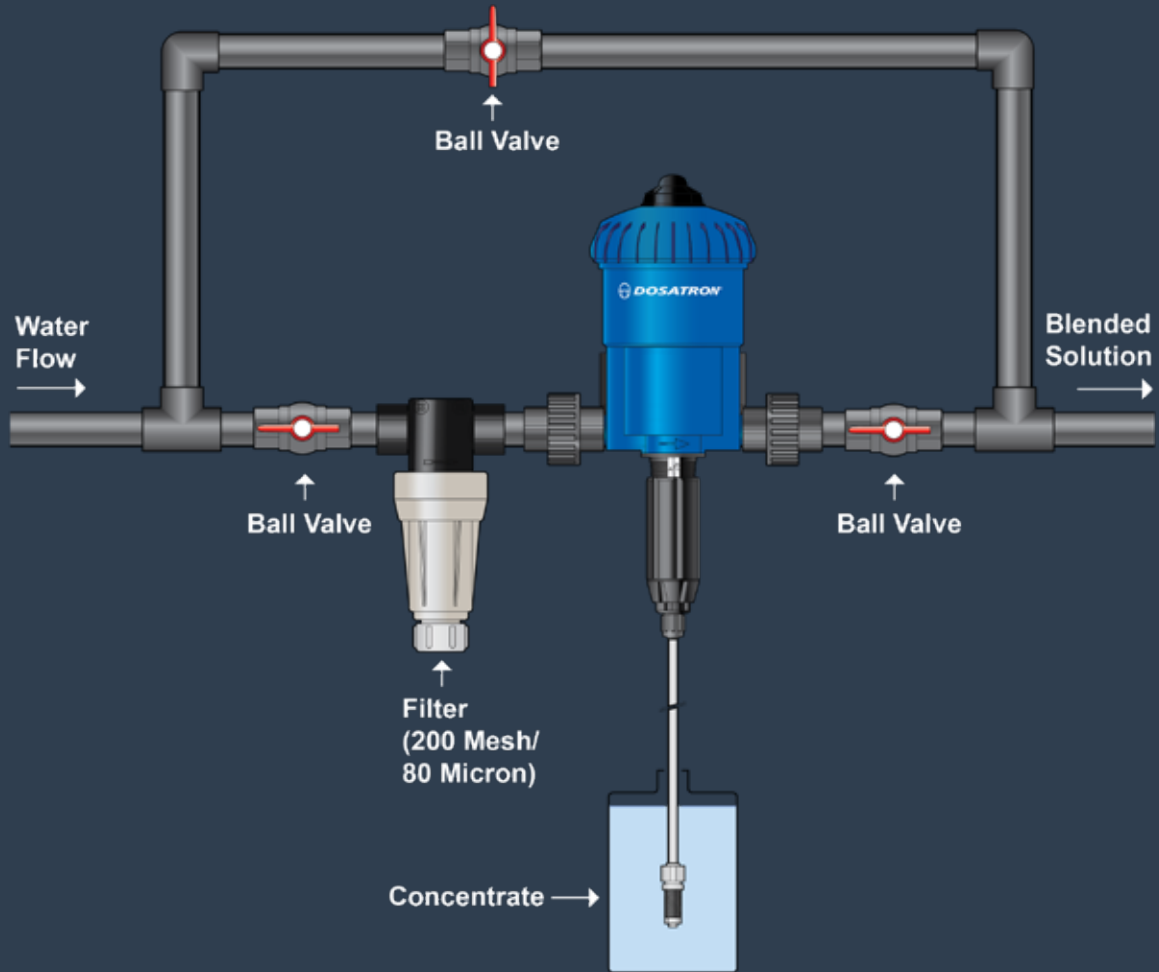

## UNIT OPERATION

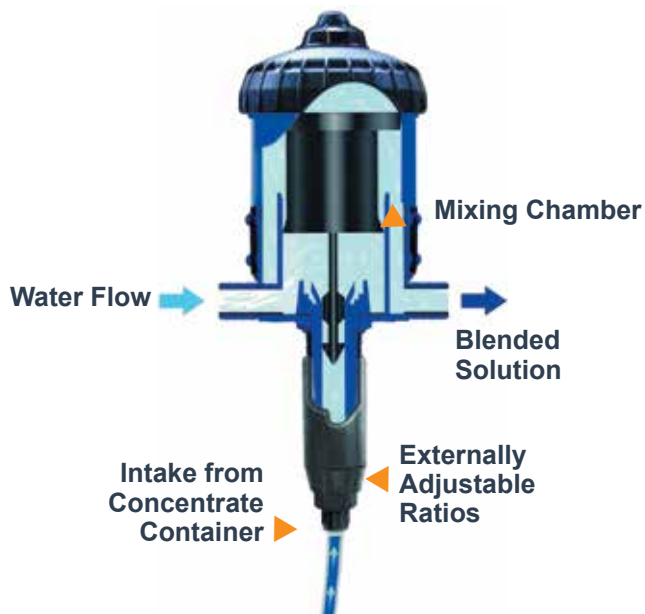

## BYPASS SWITCH

Optional manual bypass switch  
(DM11F includes built-in bypass)

 **DOSATRON**<sup>®</sup>  
**Venturi**

**LOW COST, COMPACT  
PROPORTIONER  
WITH BROAD  
INJECTION RANGE!**

**PERFECT FOR:**

- LINE CLEANING/DISINFECTING
- BOOT WASH
- VEHICLE DISINFECTING
- COOL CELL PAD CLEANING/DISINFECTING



- FEATURES**
- 3/4" Polypropylene proportioner
  - Built-in check valve
  - Restricts flow
  - Bypass valve
  - 12 large, easy-to-change, color coded tips
  - Self-cleaning
  - Injection rates of 1:100 to 1:2.3
  - Chemical resistant
  - Simple turn of bypass handle changes function from dosing to rinsing



# KNOW YOUR PH

## HM Digital Pro pH Meter

Measure the pH and temperature of the water with the easy-to-use HM Digital Pro pH Meter. The meter features:

- Low battery warning
- Waterproof body that floats
- Easy, automatic digital calibration
- Replaceable probe
- Lanyard
- Rewettable tips
- 1-year warranty
- Measures 0.00 - 14.00 pH



Part #: PH-200

## HM Digital Pro Meter Case

The meter case is a hard-sided plastic case, designed to protect the HM meter and includes a packet of calibration solution. It features:

- Injection molded polypropylene
- Prevents meter from damage
- Triple layer foam inside for added protection
- Snap locking front clasps
- Double lock loops for security



Case with Meter  
Part #: X600-102-PH

Case without Meter  
Part #: X600-102



# LIVESTOCK MEDICATION

## The Etatron e128 Medicator Electric Metering Pump

A true 11 GPM electric medicator - the Etatron **e128 Medicator** is the perfect pump for both your medicating and water treatment needs. Etatron's operation is NOT affected by water quality and is simple to use, highly reliable, and compact.

### The e128 Medicator accurately injects:

- Antibiotics / Vitamins / Vaccinations
- Electrolytes
- Chlorine
- Vinegar and Iodine
- Acidification

Etatron is a leader in electric chemical metering pumps for over 35 years.



Part #: e128



e128 Medicator
Fixed at 1:128
Pump capacity is equivalent to an 11 GPM water-powered medicator
Pump automatically compensates injection for variations in flow
Self-priming pump head with manual air bleed for fast priming
Suction alarm to detect when bucket is empty
PVDF solenoid head for enhanced chemical resistance
IP65 acid resistance housing
Long lasting, unique one-piece, Teflon® (PTFE) diaphragm design
120 Volt, 60 Hz
Connects to 1 pulse per gallon or 1 pulse per 10-gallon water meter

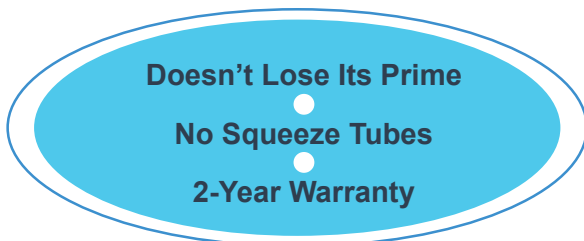

Electric Metering Pump	
MODEL	e128 Medicator
INJECTION RATE	1:128
MAXIMUM PRESSURE	101 PSI
WETTED MATERIALS	
PUMP HEAD	PVDF
DIAPHRAGM	TEFLON® (PTFE)
SUCTION TUBING	PVC
DISCHARGE TUBING	POLYETHYLENE (PE)
VALVES	CERAMIC BALL
SEALS	AFLAS® (TFE/P)

# LIVESTOCK WATER TREATMENT

## The Etatron eMP



Part #: eMP



A safe and adequate water supply is fundamental to the production of healthy animals, making a water treatment plan essential.

The Etatron eMP pump is the perfect answer to your water treatment, it is simple to use, highly reliable, and compact in size.

### The eMP features :

- Automatically adjusts injection speed to the water flow for proportional delivery
- Dual scale dial for easy stroke adjustment
- Operates with 1 pulse per 1 gallon or 1 pulse per 10 gallon water meter
- Superior diaphragm technology
- No squeeze tubes that can break
- Turns off automatically when the chemical container is empty
- Pump will turn OFF if pressure exceeds 145 PSI

### Electric Metering Pump



MODEL

eMP

INJECTION RATE

0.26 GPH (1 LPH) - MAX

MAXIMUM PRESSURE

145 PSI

### WETTED MATERIALS

PUMP HEAD

PVDF

DIAPHRAGM

TEFLON® (PTFE)

SUCTION TUBING

PVC

DISCHARGE TUBING

POLYETHYLENE (PE)

VALVES

CERAMIC BALL

SEALS

AFLAS® (TFE/P)

### Basic Installation

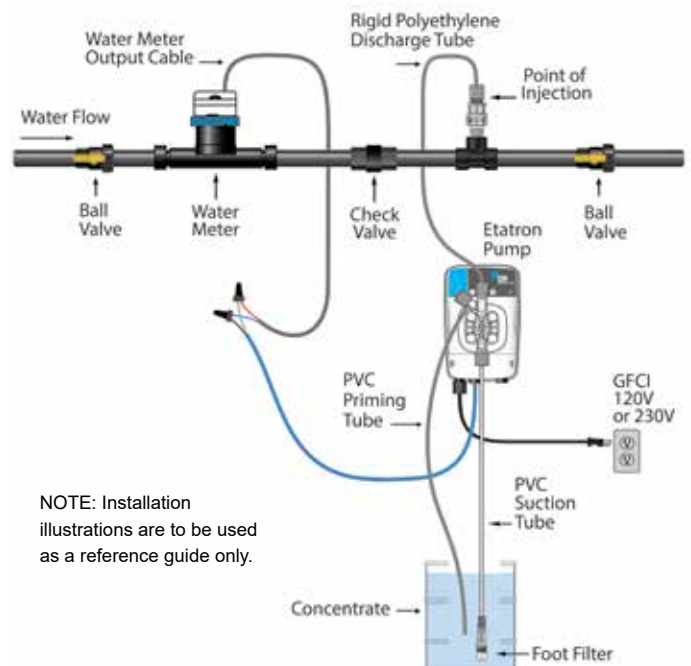



# MEDICATING MADE EASY

## ePC - Pulse Control

The Etatron ePulse Control receives a reed input signal from a water meter and sends it to up-to-four pumps. Perfect for a facility with a pulse water meter (1 pulse per 1-gallon or 1 pulse per 10-gallons) to eliminate the possibility of communication problems between devices.

### ePulse Control features:

- Signals multiple devices independently from a 1PPG or 1PP10G water meter
- LED indicator lights up for each pulse
- Prewired for up to four devices
- Just plug into power supply and connect communication wires

 **ETATRON**



Part #: **EPC-Pulse Control**

## e128 Panel With ePulse Control



This simple to install, preassembled panel, includes the Etatron e128 Medicator and an ePulse Control. You can easily attach a 1PPG (1 pulse per 1-gallon) or 1PP10G (1 pulse per 10-gallons) water meter that is already hooked up to your house control.

### e128 Panel with ePulse Control features:

- Panel is 17" x 24"
- Pre-plumbed, simply connect 3/4" FPT to your plumbing line or by a garden hose connection
- Includes ePulse Control

Part #: **PE128.75IN1GPC**

## e128 Panel With Water Meter

The Etatron e128 Medicator, with a 3/4" 1 pulse per 1-gallon water meter, is built onto an easy-to-install panel.

### e128 Panel features:

- Ships preassembled
- Panel is 17" x 24"
- Pre-plumbed, simply connect 3/4" FPT to your plumbing line or by garden hose connection

Part #: **PE128.75IN1G**



# INSTALLATION ACCESSORIES

## Water Meter

This totalizer water meter features:

- Pulse output is 1 pulse per 1-gal or 1 pulse per 10-gals
- Available in 3/4" to 2"
- Lightweight polypropylene (3/4" - 1 1/2" pipe size)
- Brass or Stainless (2" pipe size)
- Analogue
- Reads gallons



3/4 " 1 Pulse per 1 Gallon Pictured  
Part #: WM34-1PPG (1 pulse per 1-gal)  
Part #: WM34-1PP10G (1 pulse per 10-gals)

## LIVESTOCK WATER TREATMENT INSTALLATION

Make Etatron part of your water treatment and medication plan to provide a safe and adequate water supply for the production of healthy animals.

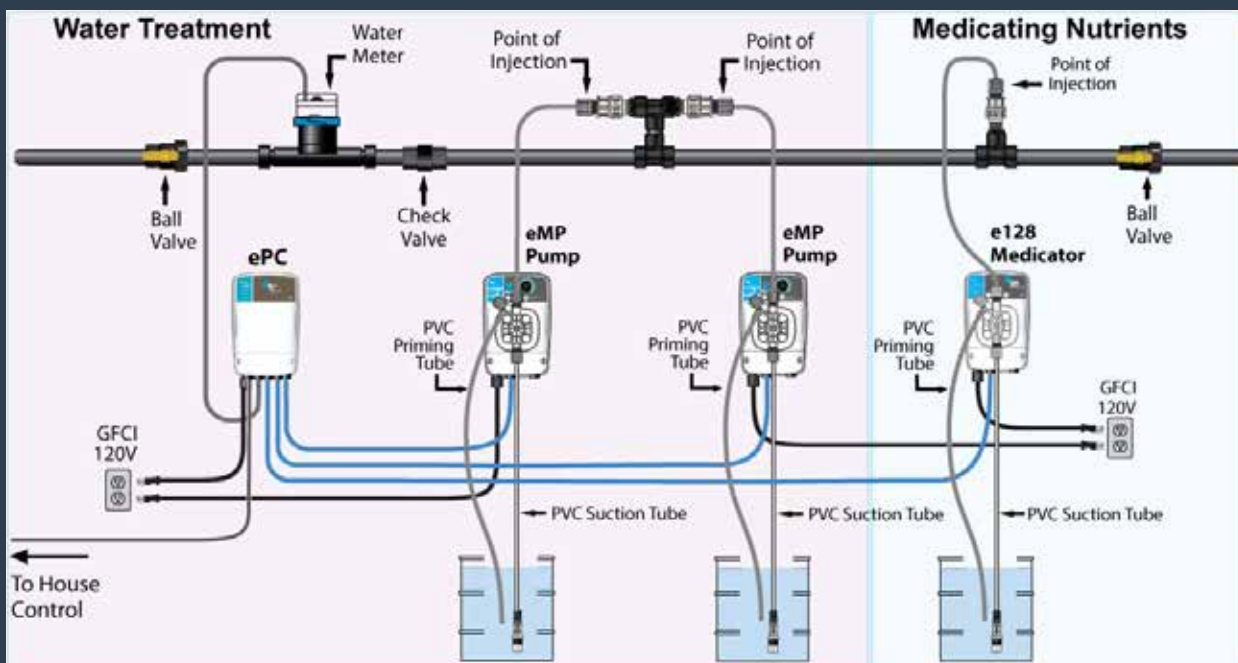

NOTE: Installation illustrations are to be used as a reference guide only.

# CONNECT



**1-800-451-6628**

Give us a call and we will be glad to answer any of your questions or take your order.



**CHAT**

It's easy to CHAT at [www.dilutionsolutions.com](http://www.dilutionsolutions.com). Just enter your question and we will be glad to assist.

**Mailing Address:**

Dilution Solutions, 2090 Sunnydale Blvd., Clearwater, FL 33765

**Hours of Operation:**

Monday - Friday, 8:30 am - 5:00 pm EST

Saturday - Sunday, Closed

**At Dilution Solutions, LLC, we have partnered with some of the top brands to make chemical delivery EASY!**

**Call Now! 1-800-451-6628 or 1-727-451-1198**



2090 Sunnydale Blvd. • Clearwater, FL 33765  
1-800-451-6628 • 1-727-451-1198 • [www.dilutionsolutions.com](http://www.dilutionsolutions.com)